

■Features

- High Luminous LEDs
- 5mm Round Standard Directivity
- Long Lifetime Operation
- Superior Weather-resistance
- Water Clear Type

■Applications

- Backlighting (switches, keys, displays, illuminated advertising etc.)
- Substitution of Micro Incandescent Lamps
- Reading Lamps / Emergency Lighting
- Marker lights (e.g. steps, exit ways, etc.)
- Other Lighting

■Absolute Maximum Rating

(Ta=25)

Item	Symbol	Value	Unit
DC Forward Current	I _F	30	mA
Pulse Forward Current*	I _{FP}	100	mA
Reverse Voltage	V _R	5	V
Power Dissipation	P _D	108	mW
Operating Temperature	T _{opr}	-30 ~ +85	
Storage Temperature	T _{stg}	-40 ~ +100	
Lead Soldering Temperature	T _{sol}	260 /5sec	-

*Pulse width Max.10ms Duty ratio max 1/10

■Outline Dimension

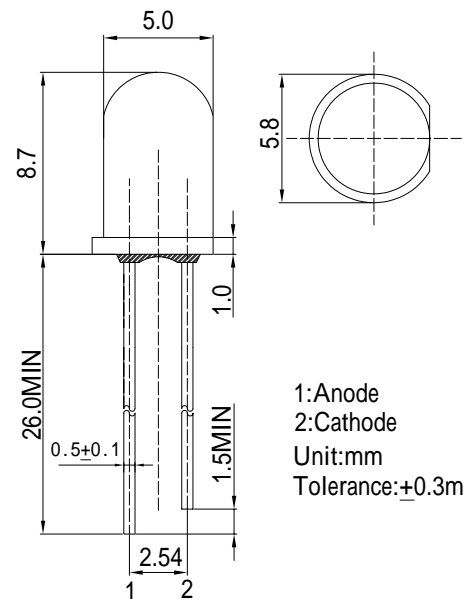

1:Anode
2:Cathode
Unit:mm
Tolerance:±0.3mm

■Directivity

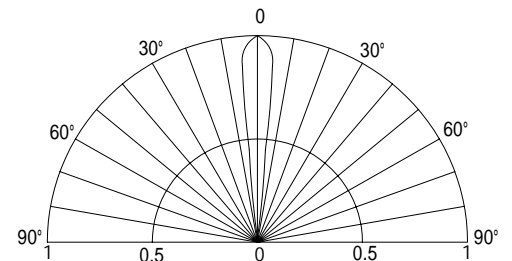

Electrical -Optical Characteristics

(Ta=25)

Item	Symbol	Condition	Min.	Typ.	Max.	Unit
DC Forward Voltage	V _F	I _F =20mA	2.8	3.1	3.6	V
DC Reverse Current	I _R	V _R =5V	-	-	10	μA
Luminous Flux	v	I _F =20mA	5.5	6.1	-	lm
Chromaticity Coordinates*	x	I _F =20mA	-	0.41	-	
	y	I _F =20mA	-	0.35	-	
50% Power Angle	2θ _{1/2}	I _F =20mA	-	15	-	deg

*1 Luminous Flux Measurement allowance is ± 15%

*2 Chromaticity Coordinates Measurement allowance is ± 10%